



Product Selection Guide

Western Region Light Gauge Offering
Post Frame, Agricultural, Residential, Light Commercial



Fabral is the premier supplier of metal roofing and siding for post frame, agricultural, residential, architectural, industrial and commercial applications and has multiple regional manufacturing locations across the US. Founded in 1967, Fabral is part of the Euramax family of companies.



REGIONAL PRODUCT GUIDE

Product Page

Exposed-Fastener Panels

Grandrib 3	2
Grandrib 3 26 ga	2
Val Rib III	2
MP Panel	3
MPV III	3
Delta Rib	4
2 1/2" Corrugated	4
Mighti-Rib	5

Value Added Program

5

Standing Seam Panels

Horizon 16	6
Ultra-Loc 16	6

Paint Systems

7

Self Storage

Secondary Structural Framing	8
Self Storage Units	8

Fasteners

9

Accessories

Translucent Panels	10
Liner Panel	10
Soffit	11
Flat Sheets	11
Tread Embossed Plate	11
Venting / Closures	12
Sealant / Sealer Strip	12
Pipe Boots	12
Underlayment	13
Door Track	13
Roof Hugger	13
Solar	14
Cupolas	14
Backer Rod	14
Snowguards	15
Additional Accessories	15

Online Resources

16

Metal Roofing is GREEN

16

Fabral is the premier supplier of metal roofing and siding for post-frame, agricultural, residential, architectural, commercial and industrial applications and has always strived to provide the highest quality products and the best service in the industry.

Our extensive product offering includes standing seam roof panels, concealed fastener and exposed fastener panels, liner panels, standard and custom flashings, complete self-storage building packages, secondary structural framing, solar systems and a complete accessory offering - many available in a wide variety of substrates including aluminum, galvanized steel, Galvalume, copper and stainless steel. In addition, our industry-leading warranties and unbeatable paint system, Enduracote®, takes performance to the next level by providing confidence and peace-of-mind.

Fabral, Inc.
3449 Hempland Road, Lancaster, PA 17601
800-477-2741
info@fabral.com
www.fabral.com

Fabral Regional Manufacturing Locations:

Cedar City, UT
800-432-2725

Salem, OR
800-477-8028

Spokane, WA
800-456-9124



*Ask about our
Energy Star
product offering*

For the complete Fabral Nationwide product offering and list of manufacturing locations, visit www.fabral.com

Due to product improvements, changes and other factors, FABRAL reserves the right to change or delete information here-in without prior notice.

Exposed Fastener Panels

Grandrib 3®

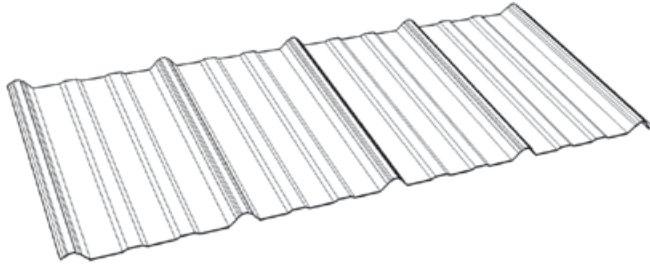

Panel Specifications:

- The original time-tested profile
- Perfect for most applications
- 36" coverage with 3/4" rib height
- High performance Enduracote paint system
- UL 790 Class A Fire Resistance Rating
- UL 2218 Class 4 Hail Impact Resistance
- UL 580 Class 90 Uplift Test Rating
- Anti-Siphon sidelap design
- Minimum pitch required 2 1/2:12
- Custom cut to lengths up to 40'

Substrates:

- 29 gauge structural quality, full-hard steel
- 26 gauge high strength steel

Warranty Information:

29 ga Grandrib 3

- Lifetime film integrity warranty for walls and roofs
- 30 year warranty against fade and chalk for walls & roofs
- 10 year edge rust warranty against acid rain

26 ga Grandrib 3

- Lifetime film integrity warranty for walls and roofs
- 30 year warranty against fade and chalk for walls & roofs
- 25 year non-perforation warranty against acid rain for walls; 20 years for roofs
- 20 year non-perforation on galvalume (26 ga unpainted)

Regional Manufacturing Locations:

- All Fabral Locations

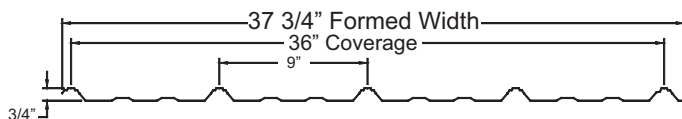

Val Rib III

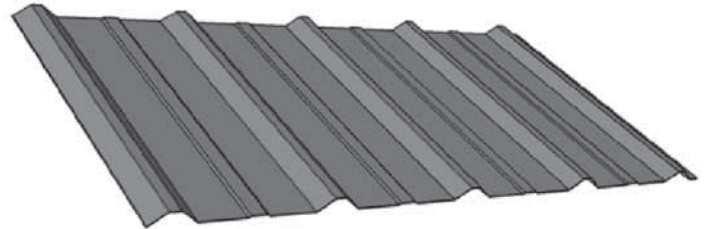

Panel Specifications:

- Perfect for most applications
- 36" coverage with 3/4" rib height
- High performance Enduracote paint system
- UL 790 Class A Fire Resistance Rating
- UL 2218 Class 4 Hail Impact Resistance
- UL 580 Class 90 Uplift Test Rating
- Anti-Siphon sidelap design
- Minimum pitch required 2 1/2:12
- Custom cut to lengths up to 40'

Substrate:

- 29 gauge structural quality, full-hard steel

Warranty Information:

- Lifetime film integrity warranty for walls and roofs
- 30 year warranty against fade and chalk for walls & roofs
- 10 year edge rust warranty against acid rain

Regional Manufacturing Location:

- Salem, OR

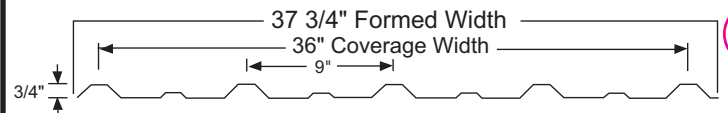

Exposed Fastener Panels



MP-Panel™

MPV III

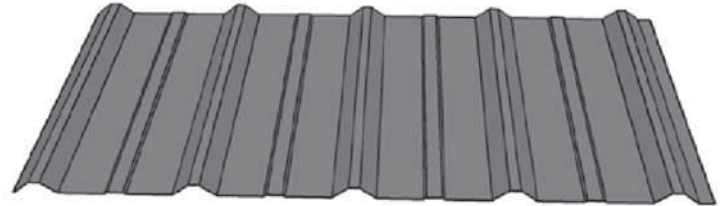
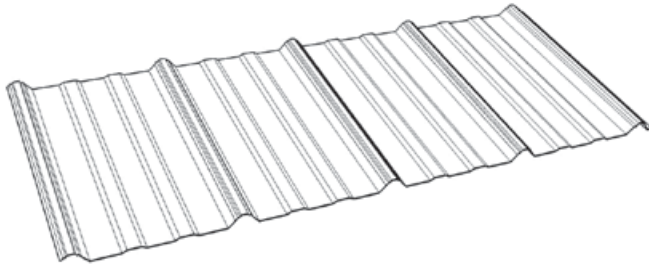

Panel Specifications:

- An economical yet durable solution for most any application
- 36" coverage with 3/4" rib height
- UL 790 Class A Fire Resistance Rating
- UL 2218 Class 4 Hail Impact Resistance
- Low maintenance
- Easy to install
- 13 popular colors
- Minimum pitch required 2 1/2:12
- Custom cut to lengths up to 40'

Panel Specifications:

- An economical yet durable solution for most any application
- 36" coverage with 3/4" rib height
- UL 790 Class A Fire Resistance Rating
- UL 2218 Class 4 Hail Impact Resistance
- Low maintenance
- Easy to install
- 13 popular colors
- Custom cut to lengths up to 40'

Substrate:

- 29 gauge steel

Substrate:

- 29 gauge steel

Warranty Information:

- 25 year limited paint warranty
- 10 year warranty against fade and chalk

Warranty Information:

- 25 year limited paint warranty
- 10 year warranty against fade and chalk

Regional Manufacturing Locations:

- All Fabral Locations

Regional Manufacturing Location:

- Salem, OR

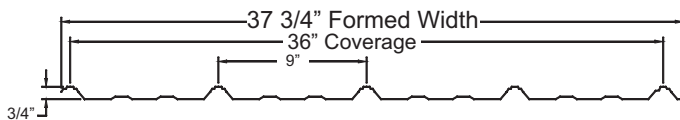

Exposed Fastener Panels

Delta Rib

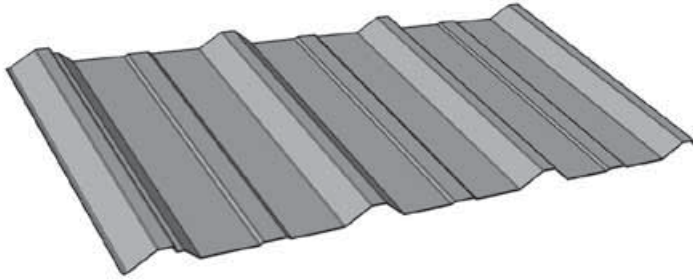

Panel Specifications:

- 24" coverage with 3/4" rib height
- High performance Enduracote paint system
- UL 790 Class A Fire Resistance Rating
- UL 2218 Class 4 Hail Impact Resistance
- UL 580 Class 90 Uplift Test Rating
- Anti-Siphon sidelap design
- Custom cut to lengths up to 40'

Substrate:

- 29 gauge steel

Warranty Information:

- Lifetime film integrity warranty for walls and roofs
- 30 year warranty against fade and chalk for walls & roofs 10 year edge rust warranty against acid rain

Regional Manufacturing Locations:

- Salem, OR
- Spokane, WA

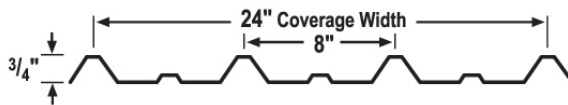

2 1/2" Corrugated



Panel Specifications:

- Perfect for barns and other agricultural applications
- 24" coverage with 1/2" rib height
- Custom cut lengths up to 40'

Substrates:

- 29 gauge steel

Regional Manufacturing Location:

- Salem, OR

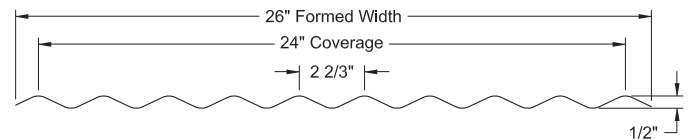

Exposed Fastener

Value Added Program

Mighti-Rib® PBR

Authorized Contractor - *coming soon*

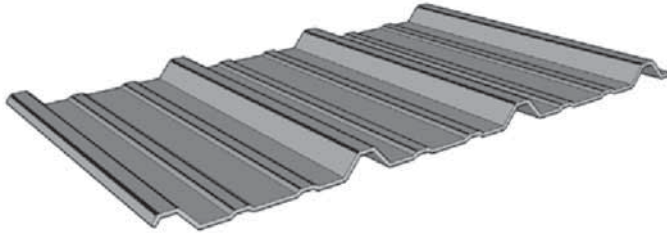

Panel Specifications:

- Perfect for commercial and industrial applications
- Durable choice for roofing and siding needs
- 36" coverage with 1 1/4" rib height
- High performance Enduracote paint system
- UL 580 Class 90 Uplift Test Rating
- UL 790 Class A Fire Resistance Rating
- UL 2218 Class 4 Hail Impact Resistance
- Includes a purlin bearing leg
- Minimum pitch required 1:12
- Custom cut to lengths up to 40'

Substrates:

- 26 gauge Galvalume steel

Warranty Information:

- Lifetime film integrity warranty for walls and roofs
- 30 year warranty against fade and chalk for walls & roofs
- 20 year non-perforation warranty

Regional Manufacturing Locations:

- Cedar City, UT
- PBR is produced in Salem, OR and Spokane, WA

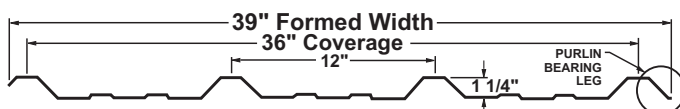

Fabral Authorized Contractors are leaders in their marketplace. They value access to information, sales tools, marketing materials, training and the widest range of products and accessories available in the industry.

Membership Benefits include:

Training. Access to training by industry experts.

Product Support. Unparalleled assistance.

Sales Tools. Receive an array of professional selling aids, such as product binders and literature, PowerPoint presentations, and top-notch displays.

Online Resources. Convenient access to our web resources, including the color visualizer and install videos.

Sales Leads. Access to leads in your market area to help you expand your business.

Promotions. Participation in exclusive promotions and points programs.

Advertising Dollars. Coop funds for promotional materials.

Public Relations. Access to PR support and sponsorship for industry organizations.

Communication. Connected by email with monthly industry news updates.



Ask for an application.

Standing Seam Panels

Horizon 16



Panel Specifications:

- Concealed fastening system
- Easy installation
- Stiffening ribs for added strength
- Light weight, energy efficient and fire resistant
- Minimum pitch required 3:12
- Easy to install-can be installed over solid decking or over an existing roof
- High performance Enduracote™ paint system
- Energy Star approved standard color offering

Substrate:

- 26 gauge Galvalume steel

Warranty Information:

- Lifetime film integrity warranty for walls and roofs
- 30 year warranty against fade and chalk for walls and roofs
- 20 year non-perforation warranty

Regional Manufacturing Locations:

- Salem, OR
- Cedar City, UT



Ultra-Loc 16

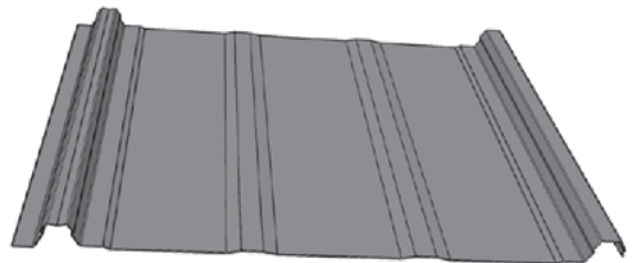

Panel Specifications:

- Concealed fastening system
- Easy installation
- Stiffening ribs for added strength
- Light weight, energy efficient and fire resistant
- Minimum pitch required 3:12
- Easy to install-can be installed over solid decking or over an existing roof
- High performance Enduracote™ paint system
- Energy Star approved standard color offering

Substrate:

- 26 gauge Galvalume steel

Warranty Information:

- Lifetime film integrity warranty for walls and roofs
- 30 year warranty against fade and chalk for walls and roofs
- 20 year non-perforation warranty

Regional Manufacturing Locations:

- Salem, OR
- Spokane, WA



Paint Systems

Enduracote® Paint System

Enduracote is a paint system that takes performance to the next level. Based on cutting edge resin technology, this system offers unbeatable durability and superior long-term performance.

- 10 layers of protection
- Unbeatable durability
- Superior long-term performance
- Low maintenance
- Many colors (offering varies by panel)
- Energy Star® offering
- Industry leading warranty



Ask about our Energy Star product offering

10 Layers of protection:

Galvanized Layers

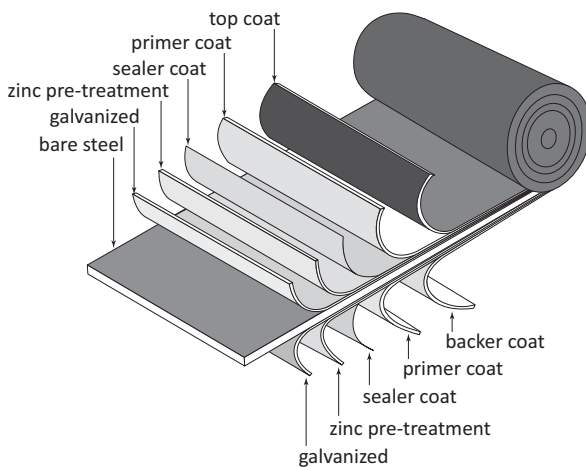

Galvalume Layers

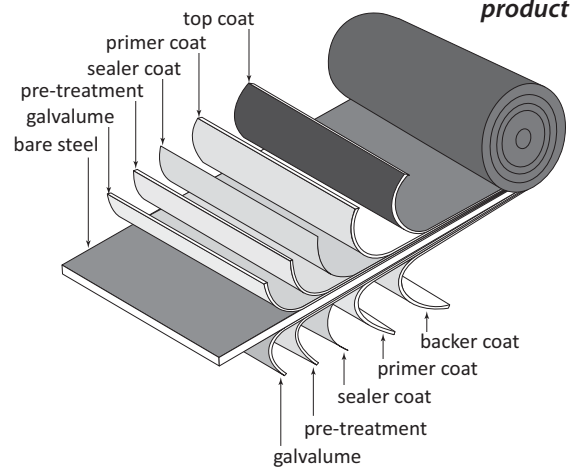

		Grandrib 3 (Produced in All Locations) 29 GA.	Val Rib III (Produced in Salem, OR) 29 GA.	MPV III* (Produced in Salem, OR) 29 GA.*	MP-Panel* (Produced in All Locations) 29 GA.*	2 1/2" Corr. (Produced in Salem, OR) 29 GA.	Delta Rib (Produced in Salem, OR & Spokane, WA) 29 GA.	Mighti-Rib (Produced in Cedar City, UT) 26 GA.	PBR (Produced in Salem, OR & Spokane, WA) 26 GA.	Horizon I6 (Produced in Salem, OR & Cedar City, UT) 26 GA.	Ultra-Loc I6 (Produced in Salem, OR & Spokane, WA) 26 GA.
Brite White	824/193*	X	X	X	X	X	X	X	X		
White	899/169*	X	X	X	X			X		X	X
Ivory	883/180*	X	X	X	X	X	X	X			
Light Stone	887/181*	X	X	X	X			X	X		
Tan	855/192*	X	X	X	X			X	X		
Cocoa Brown	856/172*	X	X	X	X	X	X	X	X		
Dark Brown	859	X	X			X	X				
Antique Bronze	854	X	X					X	X	X	X
Caribbean Blue	881/182*	X	X	X	X			X	X	X	X
Gallery Blue	826	X	X					X	X		
Brick Red	898/187*	X	X	X	X	X	X	X	X	X	X
Brite Red	845	X	X								
Classic Burgundy	853/156*	X	X	X	X					X	X
Hickory Moss	870/179*	X	X	X	X	X	X	X	X		
Patina Green	893	X	X								
Evergreen	875/176*	X	X	X	X	X	X	X	X	X	X
Light Gray	889/178*	X	X	X	X	X	X	X	X	X	X
Charcoal Gray	851/157*	X	X	X	X			X	X	X	X
True Black	882	X	X								
Hartford Green	821	X	X			X	X	X	X	X	X
Bright Copper Penny	939	X	X							X	X

* 800 series numbers reference the Enduracote Warranty paint color code; 100 series numbers reference the 25-year paint color code

Self Storage

Secondary Structural Framing

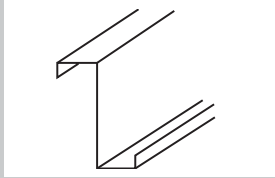

Zee

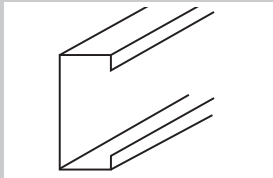

Cee

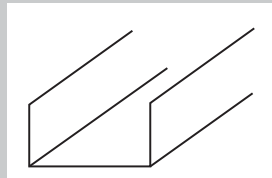

Channel

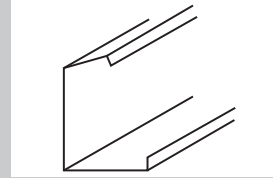

Eave Strut

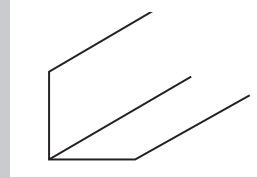

Angles

- Available in 16 gauge , 14 gauge and 12 gauge
- Zee, Cee and Channel standard sizes are 4" to 12" depths (even 2" increments)
- Angle standard sizes are 2"x 2", 2"x 4" and 3"x 3"
- Eave Strut standard sizes are 8"x 5"x 2 1/2" and 8"x 5"x 5"
- Available with hot-dipped galvanized protective coating

Self Storage Units



Components designed for fast, efficient set-up; no punching, no welding, no holes to align. The need for field fabrication is virtually eliminated. Only a small crew equipped with stepladders, screw guns and common hand tools is needed for installation.

Standard Features:

- Flexible floor plans
- Certifiable codes and loads for your local building codes
- 26 gauge roofing panels
- 30-year warranty paint system
- Free estimates and consultations
- Simple eave trims provide clean, crisp lines
- Wide selection of standard colors

Optional Features:

- Standing Seam roof panels
- Roof insulation and condensation control panels
- Roll up doors
- 29 gauge partition panels
- Engineered and stamped drawings
- Full weather seal foam closure package
- Climate control buildings

Fasteners

Fastener Offering

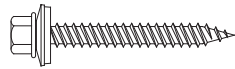

#9-16 WoodFast

- Use with dimensional lumber 5/8" plywood and thicker
- Available in 1", 1 1/2", 2", 2 1/2" and 3"
- 1/4" hex head, EPDM/metal washer
- Oxyseal Long-Life Coating
- Plain or Painted

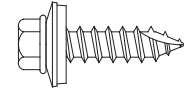

#14-10 WoodTite

- Use as stitch screw and to fasten metal to plywood or OSB
- Use for trim attachment
- Available in 1", 1 1/2" (2" and 2 1/2" special order)
- 5/16" hex head, EPDM/metal washer
- Oxyseal Long-Life Coating
- Plain or Painted

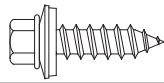

#12 - 3/4" WoodFast

- Use to attached trim to metal sheeting
- Available in 3/4"
- 1/4" hex head, EPDM/metal washer
- Oxyseal Long-Life Coating
- Plain or Painted



#12 Flat Top Tek

- Use for commercial applications
- Available in 1" and 1 1/2"
- Plain or Painted

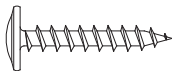

#8-1" P-Mod K-Lath

- Use with standing seam and concealed fastener panels
- Available in 1/2" and 1" P-Mod K-Lath
- Check with engineering department for spacing with OSB or 1/2" plywood
- Plain only

For more information, review Fabral's installation manuals.

Accessories

Translucent Panels

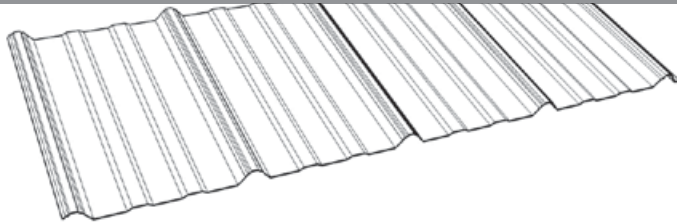

Fiberglass Product Specifications:

- Easily to clean
- High impact resistance
- Superior flexibility
- Moisture resistant
- Easily and safely installed

Available in the following panels:

- Grandrib 3, Val Rib III, Delta Rib, 2 1/2" Corrugated and Mighti-Rib/PBR (12' only)

Color:

- White

Lengths:

- 2', 8', 10' and 12' (check on availability)



Sunsy Polycarbonate Product Specifications:

- Virtually unbreakable
- Self extinguishing
- Will not yellow
- Retains optical clarity far better than other glazing material
- Wide service temperature range: 270°F to -40°F
- Easily and safely installed

Available in the following panels:

- Grandrib 3 and Mighti-Rib

Colors:

- Clear and Soft White

Lengths:

- 8', 10' and 12'

Liner Panel



Ag-Tuf Product Specifications:

- Corrugated PVC liner panel
- Attractive high-gloss white finish
- Extremely easy to handle
- Requires no special equipment to install
- Excellent chemical resistance
- Non-Flammable
- Easy cleaning & maintenance
- Great economical alternative to metal
- Excellent light reflectance
- Impact-Resistant
- Rust-Proof
- Resists marking and scratching

Call for availability.

Accessories



Soffit

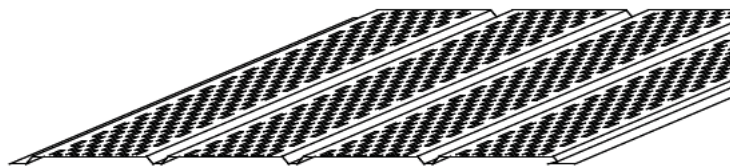

Product Specifications:

- Quad 4 Vented - allows for 12.96 sq. inch per lineal foot free airspace
- Wide range of colors
- Aluminum



Available Lengths:

16" X 12' lengths, 6 pcs / carton

Regional Stocking Locations:

- Cedar City, UT
- Spokane, WA



Tread Embossed Aluminum Sheet *Starbrite*

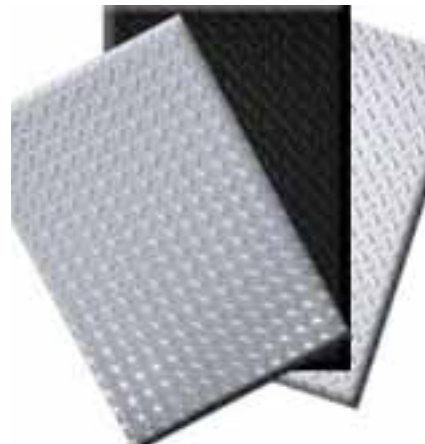

Product Specifications:

- Designed to create a visual impact indoors and outdoors
- Weather resistant finish
- Lightweight, 35% lighter than tread plate
- More cost-efficient than heavier gauge tread plate

Manufacturing Flexibility:

- Easy handling and installation
- Bends up to 90°
- Removable PVC premask protects finish

Gauges:

- Polished: .025 and .04
- Painted: .030 in white, red and black

Call for availability.

Flat Sheets

Product Specifications:

- Used for field forming for crickets around chimney, skylights and penetrations
- Used for field forming special flashing as necessary
- 29 gauge
- Painted and plain galvanized
- Full width (40' 13/16" x 10' 6")
- Grade 33 steel for better hemming, forming and flexibility for field forming
- Inquire about 26 gauge (43" x 10' 6")



Accessories

Venting / Closures

VersaVent RX-10

Product Specifications:

- Venting Factory applied to the ridge cap
- Save up to half of your installation time
- Non-profile specific material
- Clean, dust free installation. Virtually NO WASTED material.
- 1 1/2" x 3" material provides 17 sq. inches/lineal foot free area at the ridge

Also available as X-10 version (for field installation; not pre-applied to ridge cap)

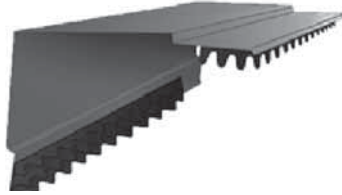

LP2 Weather-Tite Ridge Vent Product Specifications:



- Available in Horizon 16 and Ultra-Loc 16 profiles
- Lower, custom-fit profile
- Moisture and pest barrier
- Non-obtrusive appearance
- Reduces utility costs
- One-person installation

Closure Product Specifications:



Inside (Eave)



Outside (Ridge)

- Available in Grandrib 3, Val Rib III, Delta Rib, 2 1/2" Corrugated and Mighti-Rib/PBR profiles
- 10.66 sq. in. per lineal ft. of ridge (5.33 / side)

Sealant / Sealer Strip

Sealant Product Specifications:

- Waterproof sealant to fill gaps up to 1"
- UV-resistant
- Permanent flexibility - won't crack
- Standard color: gray (stocked)
- Up to 50 additional color options (non stocked)

Sealant Tape Product Specifications:

- 3/16" x 1/4" x 40'
- 3/32" x 1" x 45'
- Inquire about additional sizes

Asphalt Impregnated Sealer Strip Product Specifications:

- Use at valleys and hips
- 1" x 1" x 19'68" long

Pipe Boots

EPDM Product Specifications:

- Colors: black
- Up to 250°

Silicon Product Specifications:

- Color: orange
- Up to 450°
- Ranging for pipe sizes from 1" to 13"
- Larger sizes available on request

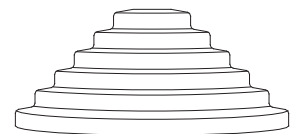

Base Diameter	Item No.	Pipe Size	
		min	max
7 3/4"	3	1/4"	5"
10 3/4"	5	4 1/4"	7 1/2"
16 1/2"	8	7"	13"

Inquire for additional sizes.

Accessories

Underlayment

Two new underlayment products - coming soon.

Peel & Stick Underlayment (also known as ice & water shield)

Product Specifications:

- High temperature, skid resistant, polyester underlayment
- Offers greater tear resistance than traditional felt underlayment
- Provides protection for critical areas such as rakes, eaves, valleys, flashings, hips, ridges, dormers and skylights
- Provides excellent low temperature flexibility
- Softening point is a minimum of 250°F

Installation Guide:

- May be installed directly to concrete, plywood, wood composition board and gypsum
- May be used in new construction or re-roofing
- Silicone-treated, split-back, release film allows for easy installation and handling
- Self seals around nails
- May be left exposed up to 90 days prior to application of finished roof

Synthetic Underlayment Product Specifications:

- 11 times less weight and 5 times more coverage than traditional felt
- Coated on both sides with a special slip resistant
- Will not support mold growth, rot, or dry out as it contains no asphalt
- 100% recyclable

Installation Guide:

- Mechanically nailed down with plastic cap nails or staples, using less fasteners per square than conventional felts
- Ideal under virtually all types of roofing
- Khaki surface that stays cooler to work on

Door Track

The Complete Door Track System:

- Door tracks
- Bottom guide systems
- Frames
- Trolleys
- Brackets
- Latches
- Rollers
- Sliding door accessories



Regional Stocking Locations:

- Salem, OR
- Spokane, WA

Roof Hugger - not stocked

Product Specifications:

- Ideal for retrofit applications
- No need to remove old roof
- Saves up to 70% of labor on preparation of old roof
- Requires only standard tools and fasteners
- 10' lengths, 16 gauge, 50 ksi steel
- Punched pilot holes for rapid fastening
- Allows for optional insulation
- Laboratory and load tested - certified load charts

Shipping from the following Roof Hugger locations:
Tampa, FL; Longview, TX; Spokane, WA; Logansport, IN

Accessories

Solar - *not stocked*
Solar SSR™

Cupolas - *not stocked*

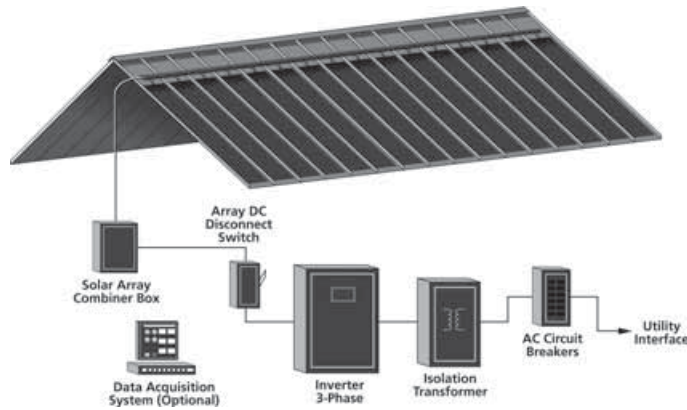

A sustainable and green solution for roofing needs.

Panel Specifications:

- Standing seam and exposed fastener applications
- Easy to install
- Return-On-Investment (ROI) of 10 years or less
- Highest relative efficiency, as compared to other type solar systems, under high temp and/or cloudy conditions
- 20-30% more efficient than crystalline in low light conditions
- Quick connect terminals
- UL approved components
- Generates 5 watts / sq. ft.

Warranty Information:

- 25 year warranty

1st Step if interested customer, complete an online Return-on-Investment (ROI) analysis form at www.fabra.com/ROI.php.

Standing Seam Application:

Solar SSR applied to standing seam panel

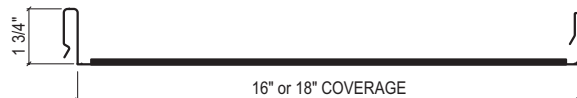

Exposed-Fastener Application:

Solar SSR applied to Grandrib 3 panel



Product Specifications:

- Available in a variety of sizes and colors
- Base sizes from
 - 24 x 24 inches
 - 36 x 36 inches
 - 48 x 48 inches
 - 66 x 66 inch is available as a special order
- Flashings built to any roof pitch
- Option of windows or louvers in the sides



Backer Rod - *not stocked*

Product Specifications:

- For use as a backing material for standing seam applications
- Round, flexible, continuous lengths of extruded, closed-cell polyethylene foam
- Limits oil canning effect

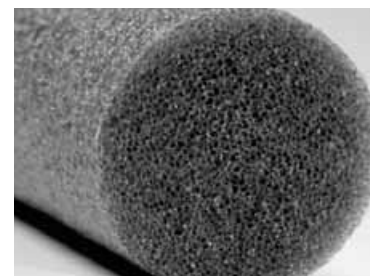

Accessories

Snowguards

Additional Accessories & Services

MINI Clear Snow Guard

Product Specifications:

- Manufactured in a premium, polycarbonate plastic
- Provides maximum protection to fit an economical budget
- The two to one base to blade ratio
- 4.5 square inch holding area and gusseted blade snow pocket combine to effectively retain snow
- Well suited for mechanical attachments with washer face screws into the purlin sealed with Surebound Everseal caulk



CL Snow Guards

Product Specifications:

- Manufactured in a clear polycarbonate with U.V. stabilizers
- Unique vent rib system allows for adhesive out gassing
- Three to one base to blade ratio adds significantly to the shear and peel adhesion of the device to the surface
- Well suited for mechanical attachments with washer face screws into the purlin sealed with Surebound Everseal caulk
- Both CL Snow Guards are 3 1/2" wide



For a complete snow guard offering, review the Fabral snow guard sell sheet.

Accessories:

- Touch up paints
- Pipe flashings
- Turbo shears
- Swenson shears
- Standing seam bending tool
- Standing seam clips
- Custom trims, flashings and gutters
- Plus many other items - talk with your Fabral Sales Representative

Color finish offering:

- 20 standard Enduracote colors (offering varies by product)
- Real Tree Camouflage (St. Joseph, MN)
- Mossy Oak Camouflage (Idabel, OK)

Services:

- Jobsite boom deliveries with cab cranes and mini booms for tight sites
- Product and installation training
- Engineering support
- Marketing support

Premium Collection:

Online for purchase at

www.fabral.com or

<http://store.apexadv.com/fabral/default.aspx>

- Wearable gear - hats, jackets, golf shirts, sweatshirts, T-shirts
- Give-a-ways

Visit fabral.com for the complete details and offering.

Online Resources & Being Green

Online Resources

Metal Roofing is *GREEN*

www.fabral.com
ftp.fabral.com
twitter

Access 24 hours, 7 days a week to:

- Online product info and tech files
- Online installation videos
- Online premium items – hats, shirts, etc.
- Online Energy Star® information and tax credit documents
- Online Return-on-Investment analysis for solar inquiries
- Online color visualizer
- Online Print-on-Demand program

PLUS ftp.fabral.com gains access to:

- Technical files
- Product images
- Product and sales PowerPoint presentations

Metal is one of the world's most recyclable materials and can be renewed and reformed generation after generation. Metal substrates are often recycled, always recyclable — and, because of their constant manufacturing stream, use and reuse, they are good for our environment and our economy.

Recyclable

Every ton of steel that is recycled from Fabral roofs saves 2500 pounds of iron ore, 1400 pounds of coal & 120 pounds of limestone. Metal roofs also offer over twice the life span of an asphalt roof - saving valuable land fill space.

Reflective Qualities & Energy Star® Approved

Fabral has attained Energy Star® approval for many panel profiles that we manufacture — available in multiple substrates and a variety of Enduracote paint system colors.

Energy Star® approved roof systems allow buildings to stay cooler and, in turn, use less electricity for air conditioning; which means a reduction in power generation and a reduction of pollutants.



Solar Integration

Fabral's Solar SSR™ system can be integrated with a variety of metal panels and offers a return of investment of 10 years or less. When it comes to generating electricity, Solar SSR offers the highest relative efficiency under high temperature and low light conditions and is up to 30% more efficient than other systems.



THINK SUSTAINABLE



CORPORATE HEADQUARTERS

3449 Hempland Road
Lancaster, PA 17604
800-477-2741 Fax 717-397-1040

ADDITIONAL Regional Manufacturing Locations

2402 Industry Way
Cedar City, UT 84720
800-432-2725 Fax 435-586-1495

17904 East 3100 North Road
Gridley, IL 61744
800-451-3974 Fax 309-747-3015

404 E Dallas Road
Grapevine, TX 76051
800-477-9066 Fax 817-488-0446

Rt. 3, Box 632, Highway 70 North
Idabel, OK 74745
800-926-8509 Fax 405-286-6007

308 Alabama Blvd.
Jackson, GA 30233
800-884-4484 Fax 770-775-6167

1820 East 26th Street
Marshfield, WI 54449
800-528-0878 Fax 715-387-2424

600 15th Avenue N.E.
Saint Joseph, MN 56374
800-873-3440 Fax 320-363-0553

4570 Ridge Drive, N.E.
Salem, OR 97303
800-477-8028 Fax 503-393-5813

East 6207 Desmet Avenue
Spokane, WA 99212
800-456-9124 Fax 509-535-3939

55 Lamb Loop
Tifton, GA 31794
800-749-8144 Fax 229-382-1770



a  Euramax company