



Product Selection Guide

Midwest Region Light Gauge Offering
Post Frame, Agricultural, Residential, Light Commercial



Fabral is the premier supplier of metal roofing and siding for post frame, agricultural, residential, architectural, industrial and commercial applications and has multiple regional manufacturing locations across the US. Founded in 1967, Fabral is part of the Euramax family of companies.



REGIONAL PRODUCT GUIDE

Product	Page
---------	------

Exposed-Fastener Panels

Grandrib 3	2
Grandrib 3 PLUS	2
Grandrib 3 26 ga	2
Mighti-Rib	2
MP Panel	3
ProClad	3
Prime Rib	4
Corrugated	4
Portable Building Panels	5

Standing Seam Panels

1 1/2" SSR	5
Climaugard	6
Ultra-Loc	6

Paint Systems

7

Value Added Program

7

Self Storage

Secondary Structural Framing	8
Self Storage Units	8

Fasteners

9

Accessories

Translucent Panels	10
Liner / Perforated Panels	10
Soffit	11
Flat Sheets	11
Tread Embossed Plate	11
Roof Hugger	11
Venting / Closures	12
Sealant / Sealer Strip	12
Pipe Boots	12
Underlayment	13
Door Track	13
Doors	13
Solar	14
Cupolas	14
Backer Rod	14
Snowguards	15
Additional Accessories & Services	15

Online Resources

16

Metal Roofing is GREEN

16

Fabral is the premier supplier of metal roofing and siding for post-frame, agricultural, residential, architectural, commercial and industrial applications and has always strived to provide the highest quality products and the best service in the industry.

Our extensive product offering includes standing seam roof panels, concealed fastener and exposed fastener panels, liner panels, standard and custom flashings, complete self-storage building packages, secondary structural framing, solar systems and a complete accessory offering—many available in a wide variety of substrates including aluminum, galvanized steel, Galvalume, copper and stainless steel. In addition, our industry-leading warranties and unbeatable paint system, Enduracote®, takes performance to the next level by providing confidence and peace-of-mind.

Fabral, Inc.
3449 Hempland Road, Lancaster, PA 17601
800-477-2741
info@fabral.com
www.fabral.com

Fabral Regional Manufacturing Locations:

Gridley, IL
800-451-3974

Marshfield, WI
800-528-0878

St. Joseph, MN
800-873-3440



*Ask about our
Energy Star
product offering*

For the complete Fabral Nationwide product offering and list of manufacturing locations, visit www.fabral.com

Due to product improvements, changes and other factors, FABRAL reserves the right to change or delete information here-in without prior notice.

Exposed Fastener Panels

Grandrib 3[®] and Grandrib 3[®] Plus

Mighti-Rib[®] PBR

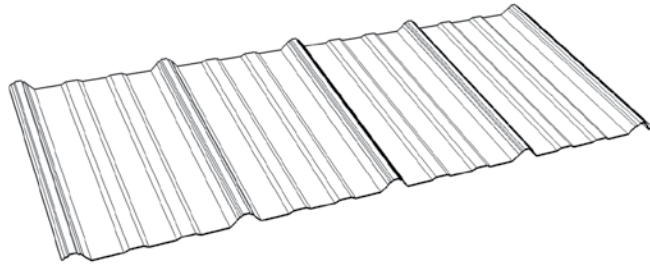

Panel Specifications:

- The original time-tested profile
- Perfect for most applications
- 36" coverage with 3/4" rib height
- High performance Enduracote paint system
- UL 790 Class A Fire Resistance Rating
- UL 2218 Class 4 Hail Impact Resistance
- UL 580 Class 90 Uplift Test Rating
- Anti-Siphon sidelap design
- Minimum pitch required 2 1/2:12
- Custom cut to lengths up to 40'

Substrates:

- 29 gauge structural quality, full-hard galvanized steel
- 26 gauge high strength galvanized steel
- .018 Aluminum

Warranty Information:

29 ga Grandrib 3 (G60)

- Lifetime film integrity warranty for walls and roofs
- 30 year warranty against fade and chalk for walls & roofs
- 10 year edge rust warranty against acid rain

26 ga Grandrib 3 (G90) and 29 ga Grandrib 3 Plus (G90)

- Lifetime film integrity warranty for walls and roofs
- 30 year warranty against fade and chalk for walls & roofs
- 15 year limited edge rust warranty painted panels
- 25 year non-perforation warranty against acid rain for walls; 20 years for roofs
- 20 year non-perforation on galvalume

Aluminum Grandrib 3

- 20 year corrosion warranty on aluminum

Regional Manufacturing Locations:

- All Fabral Locations

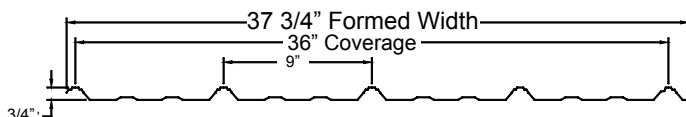

Page 2

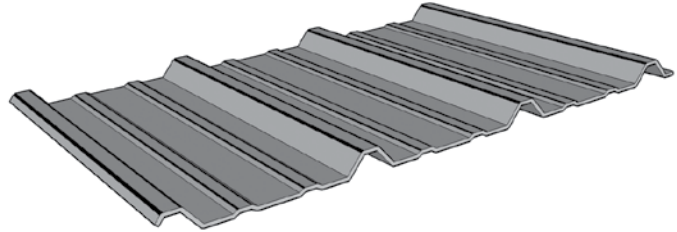

Panel Specifications:

- Perfect for commercial and industrial applications
- Durable choice for roofing and siding needs
- 36" coverage with 1 1/4" rib height
- High performance Enduracote paint system
- UL 580 Class 90 Uplift Test Rating
- UL 790 Class A Fire Resistance Rating
- UL 2218 Class 4 Hail Impact Resistance
- Includes a purlin bearing leg
- Minimum pitch required 1:12
- Custom cut to lengths up to 40'

Substrates:

- 26 gauge high strength Galvalume steel
- AZ50 painted, AZ55 plain

Warranty Information:

- Lifetime film integrity warranty for walls and roofs
- 30 year warranty against fade and chalk for walls & roofs
- 20 year non-perforation warranty

Regional Manufacturing Location:

- Gridley, IL



Exposed Fastener Panels



MP-Panel™

ProClad™

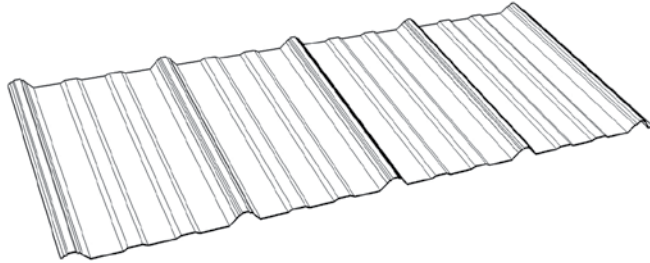

Panel Specifications:

- An economical yet durable solution for most any application
- 36" coverage with 3/4" rib height
- UL 790 Class A Fire Resistance Rating
- UL 2218 Class 4 Hail Impact Resistance
- Low maintenance
- Easy to install
- 13 popular colors
- Minimum pitch required 2 1/2:12
- Custom cut to lengths up to 40'

Substrate:

- 29 gauge galvanized steel, Grade 80

Warranty Information:

- 25 year limited paint warranty
- 10 year warranty against fade and chalk

Regional Manufacturing Locations:

- All Fabral Locations

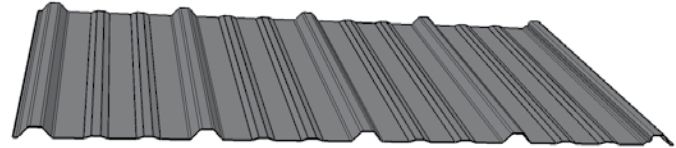
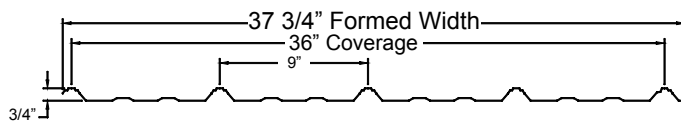

Panel Specifications:

- Ideal for agricultural, post frame and residential applications
- 36" coverage with 5/8" rib height
- A beautiful yet durable choice
- High performance Enduracote paint system
- Anti-siphon sidelap design for excellent weathertightness
- Minimum pitch required 2 1/2:12
- Custom cut to lengths up to 40'

Substrate:

- 29 gauge galvanized steel, G60

Warranty Information:

- Lifetime film integrity warranty for walls and roofs
- 30 year warranty against fade and chalk for walls & roofs
- 10 year edge rust warranty against acid rain

Regional Manufacturing Locations:

- Gridley, IL
- St. Joseph, MN



Exposed Fastener Panels

Prime Rib®

Corrugated

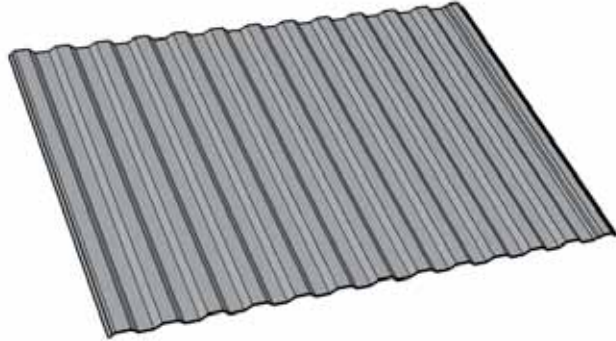

Panel Specifications:

- Perfect for barns and other agricultural applications
- 36" coverage
- High performance Enduracote paint system
- Minimum pitch required 2 ½:12
- Lengths available from 6' through 40'

Substrate:

- 29 gauge galvanized steel, G60

Warranty Information:

- Lifetime film integrity warranty for walls and roofs
- 30 year warranty against fade and chalk for walls & roofs
- 10 year edge rust warranty against acid rain

Regional Manufacturing Location:

- St. Joseph, MN

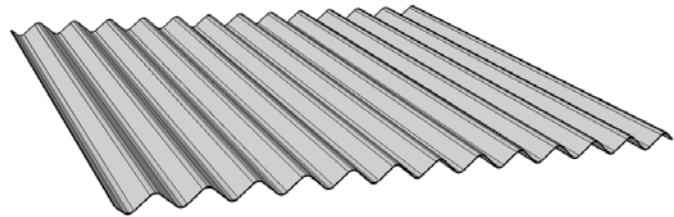
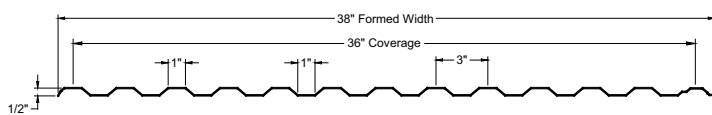

Panel Specifications:

- Perfect for barns and other agricultural applications
- 24" coverage with 1/4" or 1/2" rib height
- UL 790 Class A Fire Resistance Rating
- UL 2218 Class 4 Hail Impact Resistance
- Available in 8', 10' and 12' lengths; 25 piece skids
- Minimum pitch required 2 ½:12
- Custom cut to lengths up to 40'

Substrates:

- 29 gauge galvanized steel
- G60 painted; G90 plain
- 0.019" aluminum

Regional Manufacturing Location:

- Gridley, IL

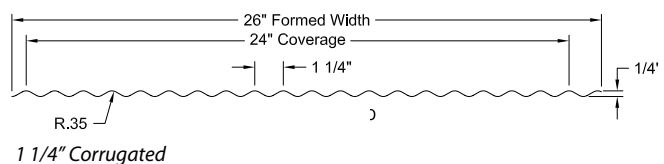
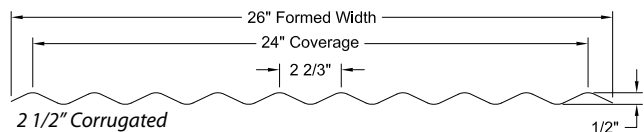

Exposed Fastener Panels

Portable Building Panels

Standing Seam Panels

1 1/2" SSR



Panel Specifications:

- Six unique profiles to choose from
Dura Lap Alutwin (24", 40" & 48")
Fabrib® 2 1/2" Corrugated
- Great looks with durable construction
- Full line of flashings & accessories
- Painted or unpainted choices
- 18 different finish and color options

Substrate:

- Aluminum (.019 and .021 - ask about availability by product)

Regional Manufacturing Location:

- Tifton, GA (Extended lead times apply)

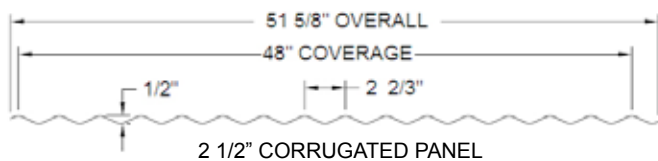
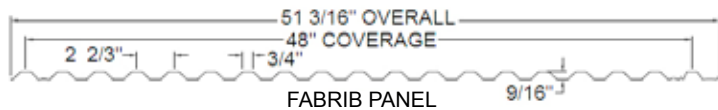
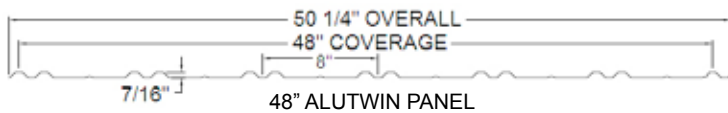
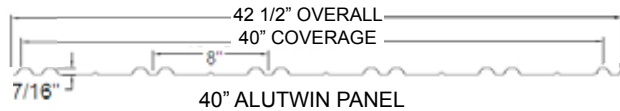
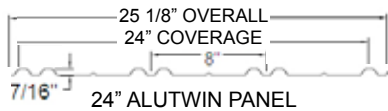
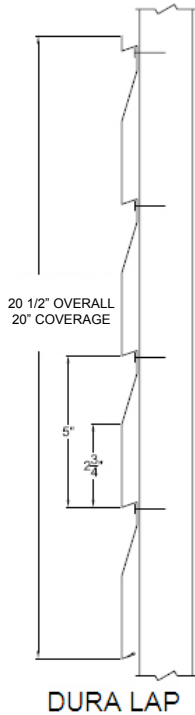

Panel Specifications:

- A high performance, classic style panel ideal for residential applications
- Designed to perform at optimum levels year after year
- Concealed clip fastening system allows for thermal movement

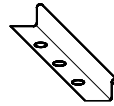

- Narrow batten standing seams
- Factory applied sealant
- Easy installation
- Light weight, energy efficient and fire resistant
- Minimum pitch required 1:12
- Minor striations available
- High performance Enduracote paint system
- Energy Star® approved standard color offering
- UL 790 Class A Fire Resistance Rating
- UL 2218 Class 4 Hail Impact Resistance

Substrate:

- 24 gauge Galvalume steel

Warranty Information:

- Lifetime film integrity warranty for walls and roofs
- 30 year warranty against fade and chalk for walls and roofs
- 20 year non-perforation warranty

Regional Manufacturing Location:

- Jackson, GA

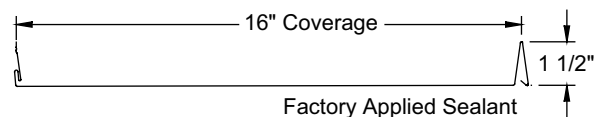

Standing Seam Panels

Climaguard™

Ultra-Loc

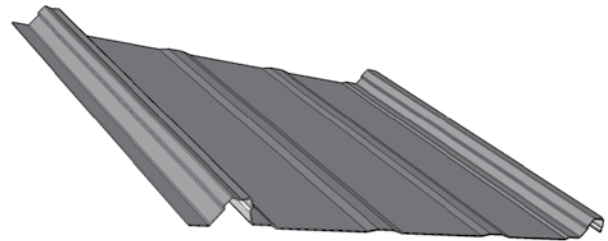
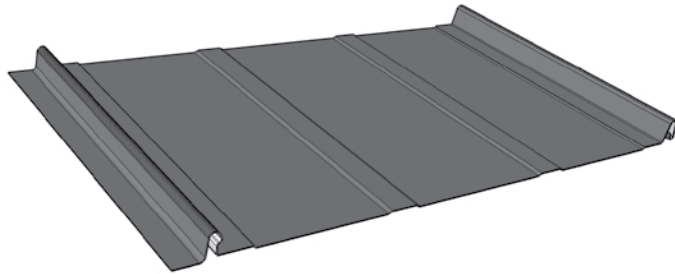

Panel Specifications:

- A snap for residential and light commercial applications
- Pre-punched fastener slots
- Stiffening ribs for added strength
- Factory applied sealant
- Easy installation
- Light weight, energy efficient and fire resistant
- Minimum pitch required 3:12
- Easy to install-can be installed over solid decking or over an existing roof
- High performance Enduracote paint system
- Energy Star® approved standard color offering
- UL 790 Class A Fire Resistance Rating
- UL 2218 Class 4 Hail Impact Resistance

Substrate:

- 26 gauge Galvalume steel

Warranty Information:

- Lifetime film integrity warranty for walls and roofs
- 30 year warranty against fade and chalk for walls and roofs
- 20 year non-perforation warranty

Regional Manufacturing Location:

- St. Joseph, MN

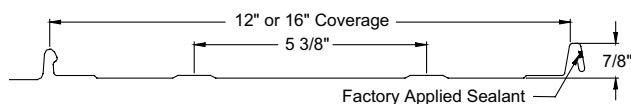

Panel Specifications:

- Concealed clip fastening system
- Easy installation
- Stiffening ribs for added strength
- Light weight, energy efficient and fire resistant
- Minimum pitch required 3:12
- Easy to install-can be installed over solid decking or over an existing roof
- High performance Enduracote paint system
- Energy Star approved standard color offering

Substrate:

- 26 gauge Galvalume steel

Warranty Information:

- Lifetime film integrity warranty for walls and roofs
- 30 year warranty against fade and chalk for walls and roofs
- 20 year non-perforation warranty

Regional Manufacturing Location:

- St. Joseph, MN

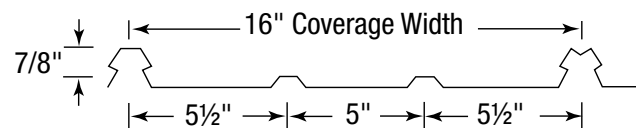

Paint Systems

Value Added Program

Enduracote® Paint System

Authorized Contractor - *coming soon*

Enduracote is a paint system that takes performance to the next level. Based on cutting edge resin technology, this system offers unbeatable durability and superior long-term performance.

- 10 Layers of protection
- Unbeatable durability
- Superior long-term performance
- Industry leading warranty
- Low maintenance
- 20 colors (offering varies by panel)
- Energy Star® offering



10 Layers of Protection

Galvanized Substrate Layers:

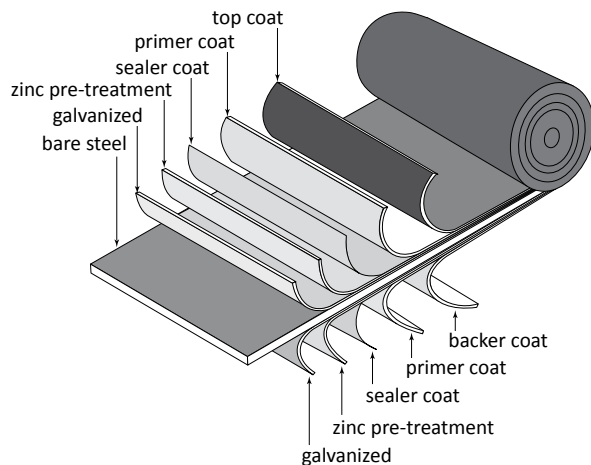

Galvalume Substrate Layers:

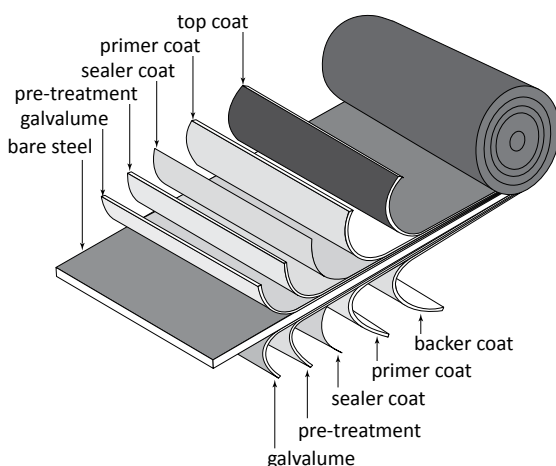

Fabral Authorized Contractors are leaders in their marketplace. They value access to information, sales tools, marketing materials, training and the widest range of products and accessories available in the industry.

Membership Benefits include:

Training. Access to training by industry experts.

Product Support. Unparalleled assistance.

Sales Tools. Receive an array of professional selling aids, such as product binders and literature, PowerPoint presentations, and top-notch displays.

Online Resources. Convenient access to our web resources, including the color visualizer and install videos.

Sales Leads. Access to leads in your market area to help you expand your business.

Promotions. Participation in exclusive promotions and points programs.

Advertising Dollars. Coop funds for promotional materials.

Public Relations. Access to PR support and sponsorship for industry organizations.

Communication. Connected by email with monthly industry news updates.



Ask for an application.

Self Storage

Secondary Structural Framing

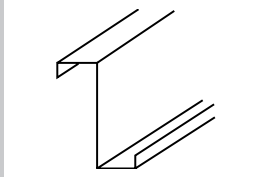

Zee

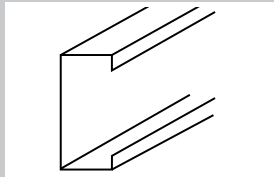

Cee

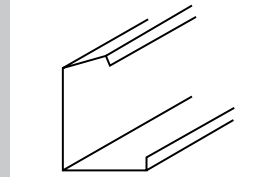
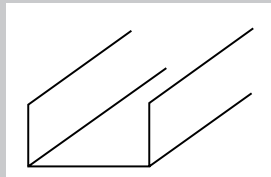

Eave Strut

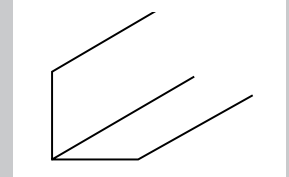

Angles

- Available in 16 gauge , 14 gauge and 12 gauge
- Zee, Cee and Channel standard sizes are 4" to 12" depths (even 2" increments)
- Angle standard sizes are 2"x 2", 2"x 4" and 3"x 3"
- Eave Strut standard sizes are 8"x 5"x 2 1/2" and 8"x 5"x 5"
- Available with either a red-oxide prime or hot-dipped galvanized protective coating

Self Storage Units



Components designed for fast, efficient set-up; no punching, no welding, no holes to align. The need for field fabrication is virtually eliminated. Only a small crew equipped with stepladders, screw guns and common hand tools is needed for installation.

Standard Features:

- Flexible floor plans
- Certifiable codes and loads for your local building codes
- 26 gauge roofing panels
- 30-year warranty paint system
- Free estimates and consultations
- Simple eave trims provide clean, crisp lines
- Wide selection of standard colors

Optional Features:

- Standing Seam roof panels
- Roof insulation and condensation control panels
- Roll up doors
- 29 gauge partition panels
- Engineered and stamped drawings
- Full weather seal foam closure package
- Climate control buildings

Fasteners

Fastener Offering

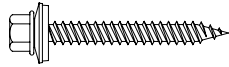

#9-16 WoodFast

- Use with dimensional lumber 5/8" plywood and thicker
- Available in 1", 1 1/2", 2", 2 1/2" and 3"
- 1/4" hex head, EPDM/metal washer
- Oxyseal Long-Life Coating
- Plain or Painted

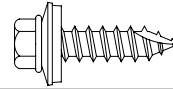

#14-10 WoodTite

- Use as stitch screw and to fasten metal to plywood or OSB
- Use for trim attachment
- Available in 1", 1 1/2", and 2"
- 5/16" hex head, EPDM/metal washer
- Oxyseal Long-Life Coating
- Plain or Painted

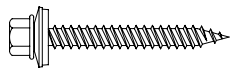

#9-16 300 Series Stainless Steel

- Use for high corrosive environments
- Use with ALUMINUM panels
- Available in 1", 1 1/2", and 2"
- 1/4" hex head, EPDM/metal washer
- Use with treated lumber
- Plain or Painted



#10-14 410 Stainless Steel

- Use with 26 gauge or thinner to avoid pre-drilling
- NOT as corrosive resistant as the 300 Series
- Steel is harder than 300 Series
- Available in 1", 1 1/2", and 2"
- 1/4" hex head, EPDM/metal washer
- Use with steel panels installed on treated lumber
- Plain or Painted

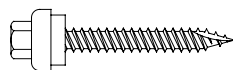

#10-16 Ultimate WoodTite

- Use with ALL panels
- Available in 1", 1 1/2", 2", 2 1/2" and 3"
- 5/16" case zinc hex head
- Hex head & washer all one piece
- Plain

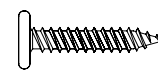

#10-1 Pancake Head

- Use with standing seam and concealed fastener panels
- Check with engineering department for spacing with OSB or 1/2" plywood
- Plain only

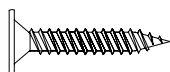

#10-12 Wafer Head

- Use with Climaguard and Ultra-Loc panels
- Check with engineering department for spacing with OSB or 1/2" plywood
- Available in 1", 1 1/2", 2" and self drillers
- Available with square drive head
- Plain only

For more information, review Fabral's installation manuals.

Accessories

Translucent Panels

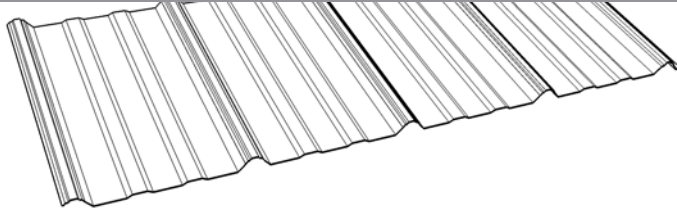

Fiberglass Product Specifications:

- Easy to clean
- High impact resistance
- Superior flexibility
- Moisture resistant
- Easily and safely installed

Available in the following panels:

- Grandrib 3, Mighti-Rib, Strongrib and Fabrib

Colors:

- White (Grandrib 3, Mighti-Rib and Strongrib)
- Green (Grandrib 3 and Fabrib)

Lengths:

- 8', 10' and 12'



Sunsky Polycarbonate Product Specifications:

- Virtually unbreakable
- Self extinguishing
- Will not yellow
- Retains optical clarity far better than other glazing material
- Wide service temperature range: 270°F to -40°F
- Easily and safely installed

Available in the following panels:

- Grandrib 3, Mighti-Rib and Ridge Caps

Colors:

- Clear and White

Lengths:

- 8', 10' and 12'

Liner Panels

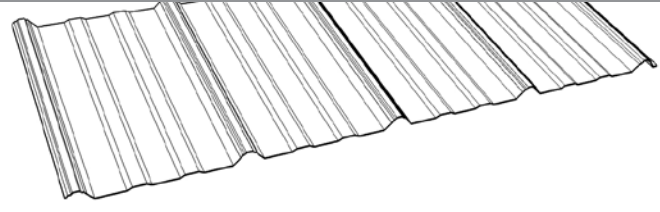

Grandrib 3 Liner Product Specifications:

- An economical light gauge panel solution
- Ideal for liners and partitions
- Perfect for field-assembled projects requiring insulated walls
- Custom cut lengths up to 40'
- Easy to clean
- Features a polyester paint system
- The Brite White color finish brightens all interiors

Grandrib 3 Acoustical Perforated Liner Product Specifications:

- Perforated to significantly reduce the reflective noise level in a structure
- Custom cut to the specified lengths
- Perforated in flat areas only to maintain profile strength and rigidity
- 36" coverage



Ag-Tuf Product Specifications - not stocked:

- Corrugated PVC liner panel
- Attractive high-gloss white finish
- Extremely easy to handle
- Requires no special equipment to install
- Excellent chemical resistance
- Non-Flammable
- Easy cleaning & maintenance
- Great economical alternative to metal
- Excellent light reflectance
- Impact-Resistant
- Rust-Proof
- Resists marking and scratching

Accessories

Soffit

Tread Embossed Aluminum Sheet *Starbrite*

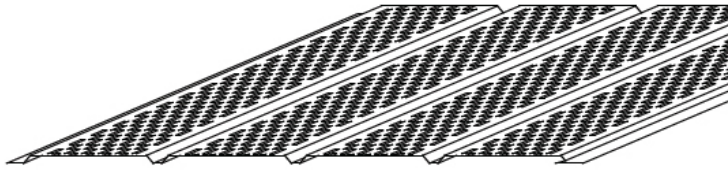

Product Specifications:

- Fully, center and non-vented soffit panels
- Pre-cut soffit—16" coverage
- Aluminum
- Quad 4 Vented - allows for 12.96 sq. inch/lineal ft free airspace
- Wide range of colors

Available Lengths:

- 11½" - 30 or 75 piece cartons
- 17½" - 15 or 75 piece cartons
- 23½" - 15 or 75 piece cartons

Regional Stocking Locations:

- Gridley, IL (solid vented)
- Marshfield, WI & St. Joesph, MN (center and non-vented)

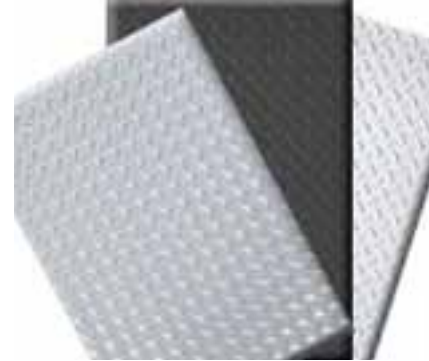

Product Specifications:

- Designed to create a visual impact indoors and outdoors
- Weather resistant finish
- Lightweight, 35% lighter than tread plate
- More cost-efficient than heavier gauge tread plate

Manufacturing Flexibility:

- Easy handling and installation
- Bends up to 90°
- Removable PVC premask protects finish

Gauges:

- Polished: .025 and .04
- Painted: .030 in white, red and black

Regional Stocking Locations:

- Gridley, IL (all colors; 48" x 120")
- Marshfield, WI (all colors; 48" x 120" and 48" x 96")

Flat Sheets

Product Specifications:

- Used for field forming for crickets around chimney, skylights and penetrations
- Used for field forming special flashing as necessary
- 29 gauge
- Painted and plain galvanized
- Full width (40' 13/16" x 10' 6")
- Grade 33 steel for better hemming, forming and flexibility for field forming

Roof Hugger - *not stocked*

Product Specifications:

- Ideal for retrofit applications
- No need to remove old roof
- Saves up to 70% of labor on preparation of old roof
- Requires only standard tools and fasteners
- 10' lengths, 16 gauge, 50 ksi steel
- Punched pilot holes for rapid fastening
- Allows for optional insulation
- Laboratory and load tested - certified load charts

Shipping from the following areas:

Tampa, FL; Longview, TX; Spokane, WA; Logansport, IN

Accessories

Venting / Closures

Sealant / Sealer Strip

VersaVent RX-10

Product Specifications:

- Venting factory applied to the ridge cap
- Save up to half of your installation time
- Non-profile specific material
- Clean, dust free installation. Virtually NO WASTED material.
- 1 1/2" x 3" material provides 17 sq. inches/lineal foot free area at the ridge

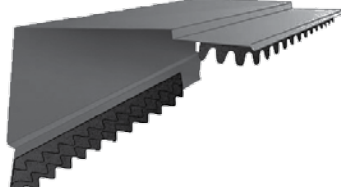

Also available as X-10 version (for field installation; not pre-applied to ridge cap)

RV35 and RV100 Product Specifications:

- 10' long metal ridge vent
- Variety of colors available

ProfileVent Product Specifications:

- Available in Grandrib 3, Alutuff and 5V profiles
- 10.66 sq. in. per lineal ft. of ridge (5.33 / side)



LP2 Weather-Tite Ridge Vent Product Specifications:



- Available in Climaguard, Grandrib 3 and Mighti-Rib profiles
- Lower, custom-fit profile
- Moisture and pest barrier
- Non-obtrusive appearance
- Reduces utility costs
- One-person installation

Closure Product Specifications:

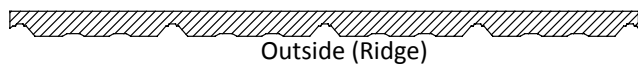
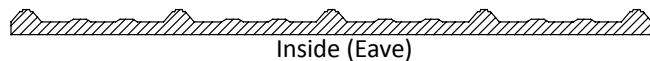

- Available in Grandrib 3, Strongrib, 1 1/4" Corrugated, 2 1/2" Corrugated and 5V profiles
- 10.66 sq. in. per lineal ft. of ridge (5.33 / side)

Sealant Product Specifications:

- Waterproof sealant to fill gaps up to 1"
- UV-resistant
- Permanent flexibility - won't crack
- Standard color: gray (stocked)
- Up to 50 additional color options (non stocked)

Sealant Tape Product Specifications:

- 3/16" x 1/4" x 40'
- 3/32" x 1/2" x 40'
- 1/8" x 2" x 30'

Asphalt Impregnated Sealer Strip Product Specifications:

- Use at valleys and hips
- 1" x 1" x 19' 6.8" long

Pipe Boots

EPDM Product Specifications:

- Colors: gray and black
- Up to 250°

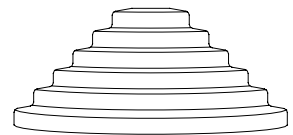

Silicon Product Specifications:

- Color: orange
- Up to 450°
- Ranging for pipe sizes from 1" to 13"
- Larger sizes available on request

Base Diameter	Item No.	Pipe Size	
		min	max
7 3/4"	3	1/4"	5"
10 3/4"	5	4 1/4"	7 1/2"
16 1/2"	8	7"	13"

Accessories

Underlayment

Two new underlayment products - coming soon.

Peel & Stick Underlayment (also known as ice & water shield)

Product Specifications:

- High temperature, skid resistant, polyester underlayment
- Offers greater tear resistance than traditional felt underlayment
- Provides protection for critical areas such as rakes, eaves, valleys, flashings, hips, ridges, dormers and skylights
- Provides excellent low temperature flexibility
- Softening point is a minimum of 250°F

Installation Guide:

- May be installed directly to concrete, plywood, wood composition board and gypsum
- May be used in new construction or re-roofing
- Silicone-treated, split-back, release film allows for easy installation and handling
- Self seals around nails
- May be left exposed up to 90 days prior to application of finished roof

Synthetic Underlayment Product Specifications:

- 11 times less weight and 5 times more coverage than traditional felt
- Coated on both sides with a special slip resistant
- Will not support mold growth, rot, or dry out as it contains no asphalt
- 100% recyclable

Installation Guide:

- Mechanically nailed down with plastic cap nails or staples, using less fasteners per square than conventional felts
- Ideal under virtually all types of roofing
- Khaki surface that stays cooler to work on

Door Track

The Complete Door Track System:

- Door tracks
- Bottom guide systems
- Frames
- Trolleys
- Brackets
- Latches
- Rollers
- Sliding door accessories



Regional Stocking Locations:

- Gridley, IL (round track)
- St. Joseph, MN (square track)

Doors

3100 Series Product Specifications:

3100 white standard stocked at St. Joseph, MN and Gridley, IL

3700 white standard and 3100 nine lite white stocked at St. Joseph, MN

- Prehung 4-way universal swing
- 1-3/4" thick door panel
- Pressure injected with polyurethane foam
- Prepainted with two coats of polyester paint

5100 Series Product Specifications:

5100 white standard stocked St. Joseph, MN and Gridley, IL

5100 nine lite white and 5100 clay standard stocked at St. Joseph, MN

- A light commercial post frame entry door
- Rolled edge door panel
- 24-gauge polyester painted galvanized steel
- Heavy internal aluminum stiles and rails
- Heavy-duty 16-gauge 3 1/2" wide painted steel jambs
- 12-gauge stainless steel 4 1/2" x 4" fixed pin hinges

The Partner Door Product Specifications:

- Pre-finished/pre-hung in 6-bend steel or extruded aluminum
- Pre-hung 4-way universal swing
- 29 ga. steel exterior

The Responder Door Product Specifications:

- Pre-finished/pre-hung in 6-bend steel or extruded aluminum
- Pre-hung 2-way universal swing
- 24 ga. steel exterior

Accessories

Solar - *not stocked*
Solar SSR™

Cupolas - *not stocked*

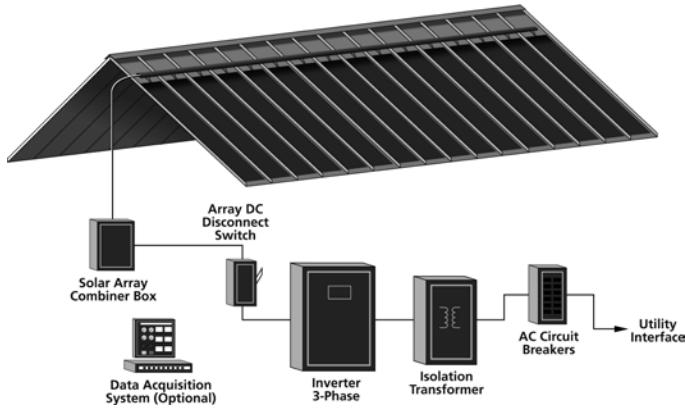

A sustainable and green solution for roofing needs.

Panel Specifications:

- Standing seam and exposed fastener applications
- Easy to install
- Return-On-Investment (ROI) of 10 years or less
- Highest relative efficiency, as compared to other type solar systems, under high temp and/or cloudy conditions
- 20-30% more efficient than crystalline in low light conditions
- Quick connect terminals
- UL approved components
- Generates 5 watts / sq. ft.

Warranty Information:

- 25 year warranty

1st Step if interested customer, complete an online Return-on-Investment (ROI) analysis form at www.fabral.com/ROI.php.

Standing Seam Application:

Solar SSR applied to 1 1/2" SSR

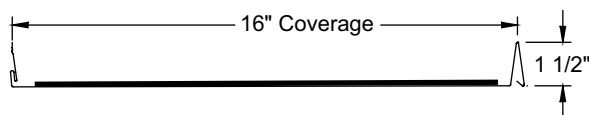

Exposed-Fastener Application:

Solar SSR applied to Grandrib 3

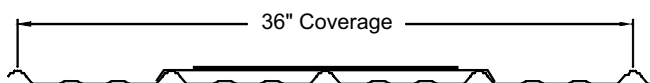

Product Specifications:

- Available in a variety of sizes and colors
- Base sizes from
 - 24 x 24 inches
 - 36 x 36 inches
 - 48 x 48 inches
 - 66 x 66 inch is available as a special order
- Flashings built to any roof pitch
- Option of windows or louvers in the sides



Backer Rod - *not stocked*

Product Specifications:

- For use as a backing material for standing seam applications
- Round, flexible, continuous lengths of extruded, closed-cell polyethylene foam
- Limits oil canning effect

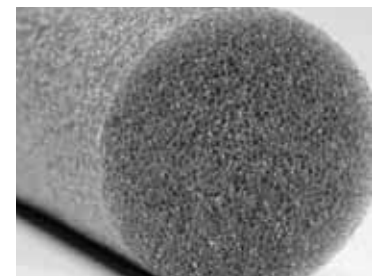

Accessories

Snowguards

MINI Clear Snow Guard

Product Specifications:

- Manufactured in a premium, polycarbonate plastic
- Provides maximum protection to fit an economical budget
- The two to one base to blade ratio
- 4.5 square inch holding area and gusseted blade snow pocket combine to effectively retain snow
- Well suited for mechanical attachments with washer face screws into the purlin sealed with Surebound Everseal caulk



CL Snow Guards

Product Specifications:

- Manufactured in a clear polycarbonate with U.V. stabilizers
- Unique vent rib system allows for adhesive out gassing
- Three to one base to blade ratio adds significantly to the shear and peel adhesion of the device to the surface
- Well suited for mechanical attachments with washer face screws into the purlin sealed with Surebound Everseal caulk
- Both CL Snow Guards are 3 1/2" wide



For a complete snow guard offering, review the Fabral snow guard sell sheet or visit fabral.com.

Additional Accessories & Services

Accessories:

- Touch up paints
- Pipe flashings
- Turbo shears
- Swenson shears
- Standing seam bending tool
- Standing seam clips
- Custom trims, flashings and gutters
- Plus many other items - talk with your Fabral Sales Representative

Color finish offering:

- 20 standard Enduracote colors (offering varies by product)
- Real Tree Camouflage (St. Joseph, MN)
- Mossy Oak Camouflage (Idabel, OK)

Services:

- Jobsite boom deliveries with cab cranes and mini booms for tight sites
- Product and installation training
- Engineering support
- Marketing support

Premium Collection:

Online for purchase at

www.fabral.com or

<http://store.apexadv.com/fabral/default.aspx>

- Wearable gear - hats, jackets, golf shirts, sweatshirts, T-shirts
- Give-a-ways

Visit fabral.com for the complete details and offering.

Online Resources & Being Green

Online Resources

Metal Roofing is *GREEN*

www.fabral.com
ftp.fabral.com
twitter

Access 24 hours, 7 days a week to:

- Online product info and tech files
- Online installation videos
- Online premium items – hats, shirts, etc.
- Online Energy Star® information and tax credit documents
- Online Return-on-Investment analysis for solar inquiries
- Online color visualizer
- Online Print-on-Demand program

PLUS ftp.fabral.com gains access to:

- Technical files
- Product images
- Product and sales PowerPoint presentations



Metal is one of the world's most recyclable materials and can be renewed and reformed generation after generation. Metal substrates are often recycled, always recyclable — and, because of their constant manufacturing stream, use and reuse, they are good for our environment and our economy.

Recyclable

Every ton of steel that is recycled from Fabral roofs saves 2500 pounds of iron ore, 1400 pounds of coal & 120 pounds of limestone. Metal roofs also offer over twice the life span of an asphalt roof - saving valuable land fill space.

Reflective Qualities & Energy Star® Approved

Fabral has attained Energy Star® approval for many panel profiles that we manufacture — available in multiple substrates and a variety of Enduracote paint system colors.

Energy Star® approved roof systems allow buildings to stay cooler and, in turn, use less electricity for air conditioning; which means a reduction in power generation and a reduction of pollutants.



Solar Integration

Fabral's Solar SSR™ system can be integrated with a variety of metal panels and offers a return of investment of 10 years or less. When it comes to generating electricity, Solar SSR offers the highest relative efficiency under high temperature and low light conditions and is up to 30% more efficient than other systems.

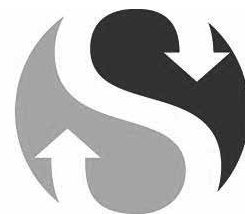

THINK SUSTAINABLE



CORPORATE HEADQUARTERS

3449 Hempland Road
Lancaster, PA 17604
800-477-2741 Fax 717-397-1040

ADDITIONAL Regional Manufacturing Locations

2402 Industry Way
Cedar City, UT 84720
800-432-2725 Fax 435-586-1495

17904 East 3100 North Road
Gridley, IL 61744
800-451-3974 Fax 309-747-3015

404 E Dallas Road
Grapevine, TX 76051
800-477-9066 Fax 817-488-0446

Rt. 3, Box 632, Highway 70 North
Idabel, OK 74745
800-926-8509 Fax 405-286-6007

308 Alabama Blvd.
Jackson, GA 30233
800-884-4484 Fax 770-775-6167

1820 East 26th Street
Marshfield, WI 54449
800-528-0878 Fax 715-387-2424

600 15th Avenue N.E.
Saint Joseph, MN 56374
800-873-3440 Fax 320-363-0553

4570 Ridge Drive, N.E.
Salem, OR 97303
800-477-8028 Fax 503-393-5813

East 6207 Desmet Avenue
Spokane, WA 99212
800-456-9124 Fax 509-535-3939

55 Lamb Loop
Tifton, GA 31794
800-749-8144 Fax 229-382-1770

